

ATRIA II 10

REIMAGINING PERFORMANCE SPACES

SPECIFICATION SHEET
ARCHI-COLOR™ W+RGB & W+Hue

Housing

Diameter : Ø9.4" | Height : 20.5" | Weight : 30 lbs

Material

Housing : High Pressure Die-Cast Aluminum
Optics : Metal Reflector

Power Input

W+RGB :
100W (White=50W, RGB=50W) | 120-277V
200W TypeA (White=100W, RGB=100W) | 120V-277V
200W TypeB (White=150W, RGB=50W) | 120V-277V
W+Hue :
100W (White=66W, HSV=33W) | 120-277V
200W (White=132W, HSV=66W) | 120V-277V

Lumen Output

W+RGB : 6,145 lm (100W), 13,255 lm (200W TypeA), 14,145 lm (200W TypeB)
W+Hue : 8,660 lm (100W), 19,635 lm (200W)

Dimming

DMX : High resolution dims to 0.1% (Supports ANSI E1.20 RDM protocol)



Color Quality

CRI 85

Rated Life

> 100,000 Hours (L70)



Finish

 
Matte Black Matte White





Color Temperature

 +  /  Archi-Color™
3000K

Optics

 45°  55°  Wide

Mounting

 Stem Mount  Adjustable Cable  Wall Mount  Yoke Mount

Warranty

5 Year limited warranty

Listing

Architecture + Color Combined

Engineered for performance spaces, this architectural compact cylinder seamlessly integrates into ceilings, delivering powerful performance with vibrant, color-changing technology that elevates any stage environment.

With Archi-Color™, Atria II provides true independent white light for commercial applications, as well as unlimited chromatic possibilities to transform spaces with colorful dynamic light.

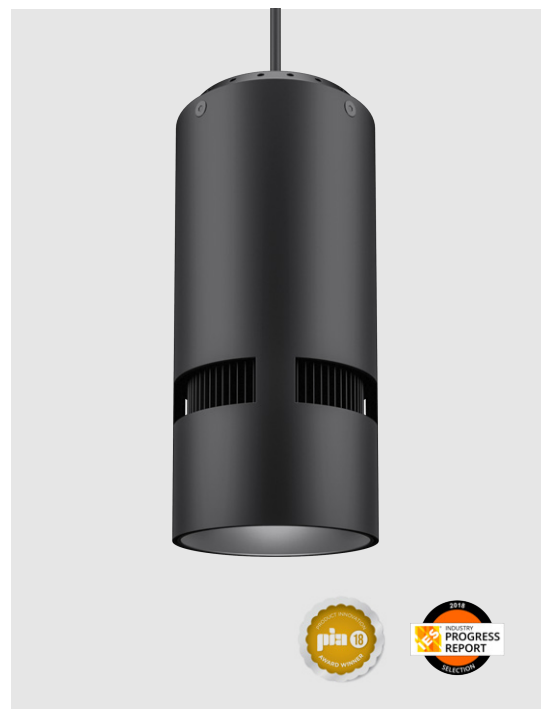

METEOR

meteor-lighting.com

SPECIFICATION

PROJECT NAME

DATE

CATALOG #

QUANTITY

The product configurator function on this page works only with the latest version of Chrome or Adobe Acrobat Reader.

AS1110	MODEL	ATRIA II 10		
<input type="text"/>	WATTAGE	100 100W	200 200W	200A 100W/100W (White=100W, RGB=100W)
<input type="text"/>	CCT / CRI	308C¹ 3000K + RGB / CRI 85 Archi-Color™ W+RGB	308U² 3000K + RGB / CRI 85 Archi-Color™ W+Hue	
UNV	VOLTAGE	UNV 120 – 277V		
<input type="text"/>	DIMMING	DMX DMX dims to 0.1% (XLR Sockets)	DMXR DMX dims to 0.1% (RJ45 Sockets)	DMXP DMX dims to 0.1% (Terminal Block)
<input type="text"/>	BEAM ANGLE	45 45°	55 55°	WD³ Wide
<input type="text"/>	FINISH	BLK SilentBlack™, Matte Finish	WHT SilentWhite™, Matte Finish	
<input type="text"/>	MOUNTING	ST2 Stem 2ft SAD10 Sloped Adjustable Cable 10ft	ST4 Stem 4ft WLM⁴ Wall Mount	AD10 Adjustable Cable 10ft YKM Yoke Mount
<input type="text"/>	ACCESSORIES	SPD⁵ Surge Protector FCS⁸ Field Cut Stem Adapter Kit	HC⁶ Honeycomb Louver	CT⁷ Conduit Mount

CLEAR FORM

¹ 308C is not compatible with 200

² 308U is not compatible with 200A, 200B

³ WD option reduces delivered lumens by ~20%

⁴ WLM is not compatible with DMX, DMXR, DMXP; connections are hard-wired using three DMX wires

⁵ Surge protector for up to 10KV. Applicable for unstable mains or facilities using high power machineries

⁶ HC option reduces delivered lumens by ~30%

⁷ CT is not compatible with YKM, WLM

⁸ FCS is not compatible with AD10, SAD10, YKM, WLM

TECHNICAL DETAILS

Electrical

- Archi-Color™ W+RGB :
 - 6,145 lm (100W | White = 50W, RGB = 50W)
 - 13,255 lm (200W TypeA | White = 100W, RGB = 100W)
 - 14,145 lm (200W TypeB | White = 150W, RGB = 50W)
- Archi-Color™ W+Hue :
 - 8,660 lm (100W | White = 66W, HSV = 34W)
 - 19,635 lm (200W | White = 132W, HSV = 66W)
- Power Input : Universal (120-277V)
- Operating Temperature : -13°F~112°F
- Surge Protection : Built-in is 4KV
- Power Factor Greater than 0.9

LED Features

- Color Temperature : 3000K + Archi-Color™ W+RGB / W+Hue
- CRI 85
- Long lasting LED luminaire tested under TM21 lumen maintenance L70 @ 100,000 Hrs
- Lumen Maintenance > 0.90 at 60,000 hours

Optics

- Precision molded high transmittance clear PC lens
- Beam Angle : 45°, 55°, WD

Advanced Dimming

- Proprietary VX Driver™ is incorporated to all dimming options for video flicker-free lighting
- DMX : High resolution dims to 0.1% (Supports ANSI E1.20 RDM protocol)

Housing

- Diameter : Ø9.4"
- Height : 20.5"
- Material : High Pressure Die-Cast Aluminum, Metal Reflector
- Weight : 30 lbs

Mounting

- Stem 2ft or 4ft; 45° Swivel Canopy Included
- Adjustable Cable 10ft
- Sloped Adjustable Cable 10ft
- Wall Mount
- Yoke Mount

Warranty

- 5-year limited warranty

Listing

- ETL Damp Location Listed
- CE
- UKCA
- FCC

PERFORMANCE SUMMARY*

Lumen Performance (W+RGB)				
	R	G	B	W
100W	220lm	1,700lm	210lm	4,015lm
200W Type A	615lm	4,075lm	485lm	8,080lm
200W Type B	220lm	1,700lm	210lm	12,015lm

Wattage (W+RGB)				
Channel	R	G	B	W
Fixture Wattage				
100W	17W	17W	17W	50W
200W Type A	33W	33W	33W	100W
200W Type B	17W	17W	17W	150W

*Beam Angle: 45° *Tolerance ±8%

Lumen Performance (W+Hue)				
	R	G	B	W
100W	340lm	3,170lm	385lm	4,765lm
200W	1,025lm	8,065lm	955lm	9,590lm

Wattage (W+Hue)		
Channel	HSV*	W
Fixture Wattage		
100W	33W	66W
200W	66W	132W

*The output power of any color generated through the three channels of HSV.

*Beam Angle: 45° *Tolerance ±8%

Current Consumption		
Voltage	120V	277V
Fixture Wattage		
100W	0.9A	0.45A
200W	1.8A	0.9A

PHOTOMETRICS

Below is a typical photometric representation of the Atria II 10 fixture. Please download IES files to ensure exact photometric value.

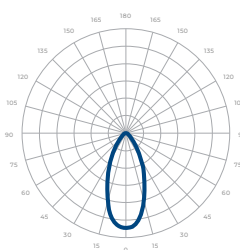

45°

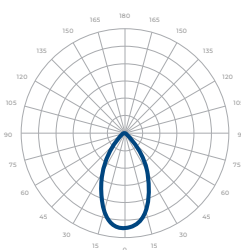

55°

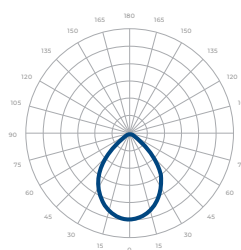

Wide

DMX REQUIREMENTS

The Atria II 10 Archi-Color™ fixture with DMX is a **four channel dmx** unit. When placing an order, please indicate DMX address. (The DMX address will be listed on the back of the fixture). Do not connect more than 32 fixtures per DMX daisy chain.

DMX Address (W+RGB)				
Channel Fixture	Red Control (ex. X)	Green Control (ex. X+1)	Blue Control (ex. X+2)	White Control (ex. X+3)
#1	1	2	3	4
#2	5	6	7	8
#3	9	10	11	12

DMX Address (W+Hue)				
Channel Fixture	Hue (H)	Saturation (S)	Value / Intensity (V)	White Control (W)*
#1	1	2	3	4
#2	5	6	7	8
#3	9	10	11	12

*The White Control channel adjusts the brightness of 3000K LEDs.

DMX REQUIREMENTS

The fixture can be connected with RJ45 or XLR sockets. DMX cables **are not** included; please refer to compatible DMX cabling list for more information. The final fixture on each daisy chain should be terminated by the use of a DMX terminator purchased from a 3rd party or from Meteor.

CONNECTION	RJ45 (CAT5e)	5-PIN XLR
Common	WHITE/BROWN (PIN 7) & BROWN (PIN 8)	PIN 1
Signal -	ORANGE (PIN 2)	PIN 2
Signal +	WHITE/ORANGE (PIN 1)	PIN 3
Spare	-	PIN 4
Spare	-	PIN 5

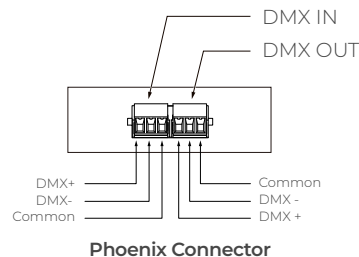
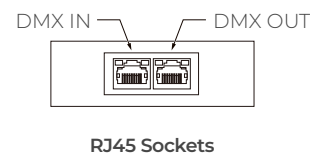

COMPATIBLE DMX CABLING LIST

DMX uses a cable consisting of two twisted pairs plus a shield to carry data. The cable must be specifically impedance matched for the digital DMX signal, meaning that microphone cable or other non-rated cable must not be used to carry DMX. Network cable (Cat5, 5e or 6 cable) may be used to carry DMX in an installation; however special consideration must be given to shielding and termination. Under no circumstances should solid core cable like Cat5 be terminated into a screw down connector.

Meteor recommends the use of Belden 9729 or Belden 9841 for DMX installation. Belden 9729/9841 is a two pair cable, which allows for a spare pair for 'out and back' type terminations if needed.

COLOR TEMPERATURE CHART

This color temperature chart provides the precise values required to recreate specific color temperatures.

Color Temperature Chart (W+Hue)				
Channel	1	2	3	4
COLOR/CCT	Hue (H)	Saturation (S)	Value / Intensity (V)	White Control (W)*
RED	0	255	255	0
GREEN	85	255	255	0
BLUE	170	255	255	0
1900K	16	255	255	90
2700K	22	255	255	200
3000K	28	255	255	255
3500K	42	225	255	255
4000K	70	165	255	255
4500K	85	150	255	255
5000K	120	215	255	255
6500K	132	255	255	237

*The White Control channel adjusts the brightness of 3000K LEDs.

DIMENSIONS

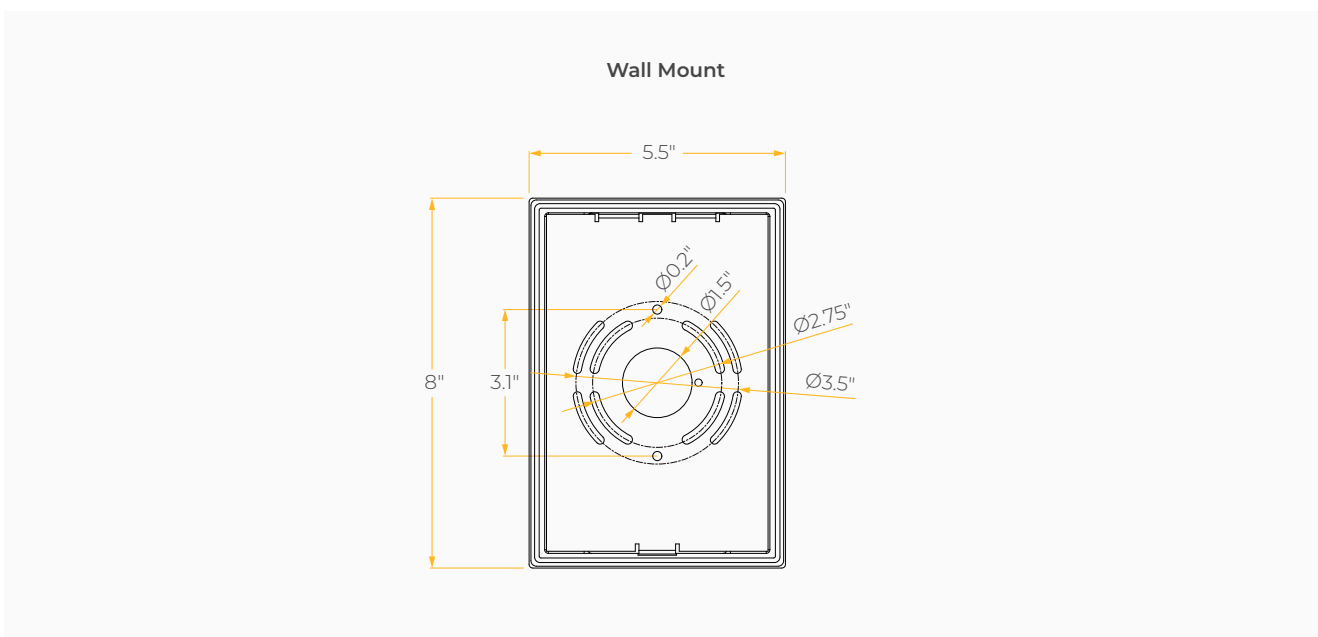
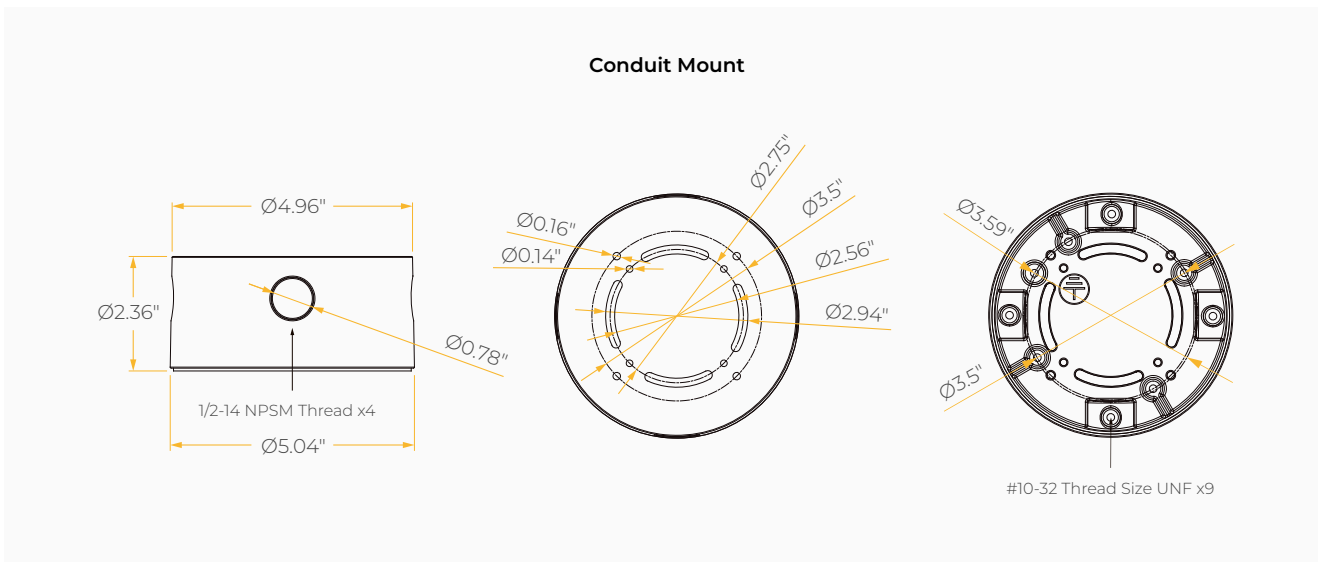
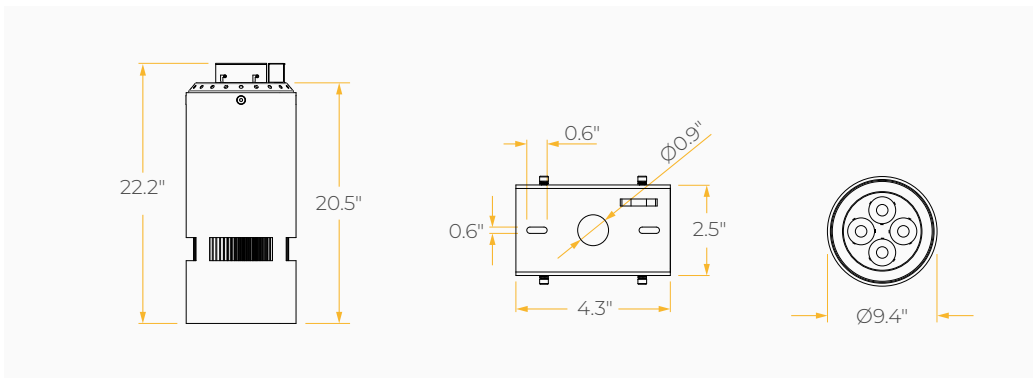

MOUNTING OPTIONS*

*Junction box not included

Stem Mount

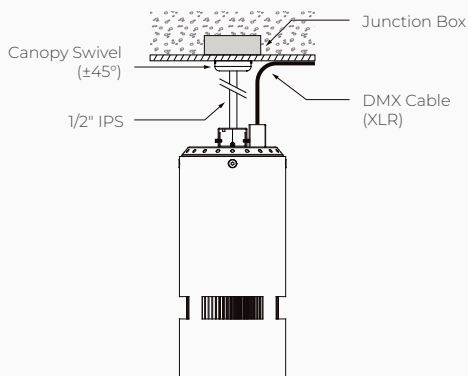

Sloped Adjustable Cable / Adjustable Cable

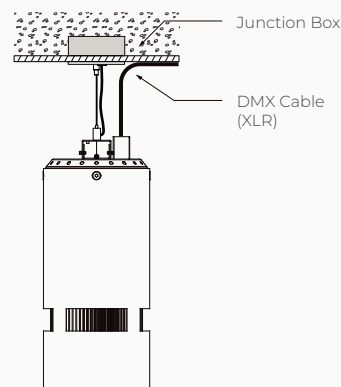

Wall Mount

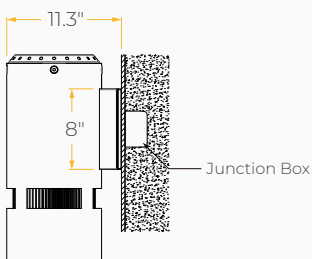

Yoke Mount

