

ATRIA II 6

REIMAGINING PERFORMANCE SPACES

SPECIFICATION SHEET
TUNABLE WHITE

Housing

Diameter : Ø6.4" | Height : 17" | Weight : 19.8 lbs

Material

Housing : High Pressure Die-Cast Aluminum
Optics : Aluminum Reflector

Power Input

40W, 60W, 80W, 100W | 120-277V

Lumen Output

3,500 lm (40W), 5,040 lm (60W), 7,215 lm (80W), 9,015 lm (100W)

Dimming

Superior 0-10V : Dims to 1%
DMX : High resolution dims to 0.1%

Color Quality

CRI 85+

Rated Life

> 100,000 Hours (L70)



Finish

Matte Black | Matte White





Color Temperature

 ColorFlip™ Tunable White
2700K ↔ 6500K

Optics

 40°
 60°
 Wide

Mounting

 Surface Mount
 Stem Mount
 Adjustable Cable
 Yoke Mount
 Wall Mount

Warranty

5 Year limited warranty

Listing

Versatile and Compact Architectural Cylinder

Engineered for performance spaces, this architectural compact cylinder seamlessly integrates into ceilings, delivering powerful performance with vibrant, color-changing technology that elevates any stage environment.

ColorFlip™ harnesses advanced flip-chip technology, designed in-house, to deliver high-efficacy, flexible, and cost-effective color tuning solutions. This technology ensures robust output and precise color accuracy.



METEOR

meteor-lighting.com

SPECIFICATION

PROJECT NAME

DATE

CATALOG #

QUANTITY

The product configurator function on this page works only with the latest version of Chrome or Adobe Acrobat Reader.

<input type="checkbox"/>	ASII6	MODEL	ATRIA II 6		
<input type="checkbox"/>		WATTAGE	40 40W 100 100W	60 60W	80 80W
<input type="checkbox"/>	TNW	CCT / CRI	TNW 2700K-6500K		
<input type="checkbox"/>	UNV	VOLTAGE	UNV 120-277V		
<input type="checkbox"/>		DIMMING	SPV Superior 0-10V dims to 1% DMXW DMX dims to 0.1% (Hard-wired)	DMX DMX dims to 0.1% (XLR Sockets)	DMXR DMX dims to 0.1% (RJ45 Sockets)
<input type="checkbox"/>		BEAM ANGLE	40 40°	60 60°	WD¹ Wide
<input type="checkbox"/>		FINISH	BLK SilentBlack™, Matte Finish	WHT SilentWhite™, Matte Finish	
<input type="checkbox"/>		RIM FINISH	STD Without Ring	GLR Glowing Ring	
<input type="checkbox"/>		MOUNTING	SUM Surface Mount AD10 Adjustable Cable 10ft WLM² Wall Mount	ST2 Stem 2ft SAD10 Sloped Adjustable Cable 10ft	ST4 Stem 4ft YKM Yoke Mount
<input type="checkbox"/>		ACCESSORIES	SPD³ Surge Protector CB⁵ Cross Baffle	EMP Remote Emergency Pack CT⁶ Conduit Mount	DF⁴ Diffuser FCS⁷ Field Cut Stem Adapter Kit

CLEAR FORM

¹ WD option reduces delivered lumens by ~20%
² WLM is not compatible with DMX, DMXR; connections are hard-wired using three DMX wires
³ Surge protector for up to 10KV. Applicable for unstable mains or facilities using high power machineries
⁴ DF option reduces delivered lumens by ~12% (~20% with WD)
⁵ CB option reduces delivered lumens by ~30%
⁶ CT is not compatible with SUM, YKM, WLM
⁷ FCS is not compatible with SUM, AD10, SAD10, YKM, WLM

TECHNICAL DETAILS

Electrical

- 3,500 lm (40W), 5,040 lm (60W)
7,215 lm (80W), 9,015 lm (100W)
- Power Input : Universal (120-277V)
- Operating Temperature : -13°F~112°F
- Surge Protection : Built-in is 4KV
- Emergency Pack with Mounting Plate : Bodine BSL20B2UEK55C111
- Power Factor Greater than 0.9

LED Features

- ColorFlip™ Tunable White 2700K ↔ 6500K
- CRI 85+
- Long lasting LED luminaire tested under TM21 lumen maintenance L70 @ 100,000 Hrs
- Lumen Maintenance > 0.90 at 60,000 hours

Optics

- Aluminum Reflector
- Beam Angle : 40°, 60°, WD

Advanced Dimming

- Proprietary VX Driver™ is incorporated to all dimming options for video flicker-free lighting
- Superior 0-10V : Dim to 1% (2 channel)
1 channel control dimming. 1 channel control CCT.
- DMX : High resolution dims to 0.1% (2 channel)
(Supports ANSI E1.20 RDM protocol)

Housing

- Diameter : Ø6.4"
- Height : 17"
- Material : High Pressure Die-Cast Aluminum
- Weight : 19.8 lbs

Mounting

- Surface Mount
- Stem 2ft or 4ft; 45° Swivel Canopy Included
- Adjustable Cable 10ft
- Sloped Adjustable Cable 10ft
- Yoke Mount
- Wall Mount

Warranty

- 5-year limited warranty

Listing

- ETL Damp Location Listed
- CE
- FCC
- UKCA

PERFORMANCE SUMMARY*

ColorFlip™	2700K	3000K	3500K	4000K	4500K	5000K	5700K	6500K
DMX CCT Signal (%)	0%	10%	25%	45%	60%	70%	85%	100%
0-10V CCT Voltage	0	1	2.5	4.5	6	7	8.5	10
40W	2,990lm	3,160lm	3,335lm	3,500lm	3,470lm	3,440lm	3,410lm	3,385lm
60W	4,310lm	4,550lm	4,800lm	5,040lm	5,000lm	4,955lm	4,910lm	4,870lm
80W	6,165lm	6,510lm	6,870lm	7,215lm	7,160lm	7,095lm	7,095lm	6,970lm
100W	7,705lm	8,140lm	8,580lm	9,015lm	8,940lm	8,865lm	8,785lm	8,715lm
CRI	85	86	87	88	88	87	86	85

*Lumen Multiplier 40° 60° baseline 0.92

PERFORMANCE SUMMARY*

Current Consumption			Emergency Pack Lumen Output Table	
WATTAGE / VOLT	120V	277V	CCT	6500K
40W	0.37A	0.16A	LUMEN	2,000lm
60W	0.55A	0.24A		
80W	0.73A	0.32A		
100W	0.92A	0.4A		

PHOTOMETRICS

Below is a typical photometric representation of the Atria II 6 fixture. Please download IES files to ensure exact photometric value.

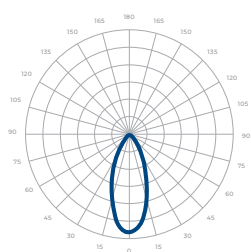

40°

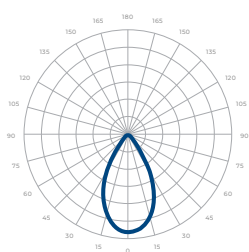

60°

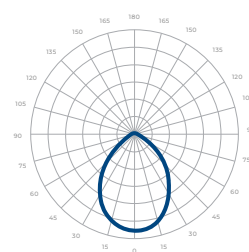

Wide

DMX REQUIREMENTS

The Atria 6 Tunable White fixture with DMX unit has **two channels** per fixture (1 to control intensity, 1 to control color). When placing an order, please indicate DMX address. (The DMX address will be listed on the back of the fixture). Do not connect more than 32 fixtures per DMX daisy chain.

Fixture	DMX Address	
	Intensity Control (ex. X)	Color Control (ex. X+1)
#1	1	2
#2	3	4
#3	5	6

DMX REQUIREMENTS

The fixture can be connected with RJ45 or XLR sockets. DMX cables **are not** included; please refer to compatible DMX cabling list for more information. The final fixture on each daisy chain should be terminated by the use of a DMX terminator purchased from a 3rd party or from Meteor.

CONNECTION	RJ45 (CAT5e)	5-PIN XLR
Common	WHITE/BROWN(PIN7) & BROWN (PIN 8)	PIN 1
Signal -	ORANGE (PIN 2)	PIN 2
Signal +	WHITE/ORANGE (PIN 1)	PIN 3
Spare	-	PIN 4
Spare	-	PIN 5

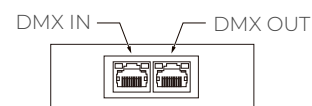

RJ45 Sockets



DMX IN DMX OUT

XLR Sockets

COMPATIBLE DMX CABLING LIST

DMX uses a cable consisting of two twisted pairs plus a shield to carry data. The cable must be specifically impedance matched for the digital DMX signal, meaning that microphone cable or other non-rated cable **must not be used to carry DMX**. Network cable (Cat5, 5e or 6 cable) may be used to carry DMX in an installation; however special consideration must be given to shielding and termination. Under no circumstances should solid core cable like Cat5 be terminated into a screw down connector.

Meteor recommends the use of Belden 9729 for DMX installation. Belden 9729 is a two pair cable, which allows for a spare pair for 'out and back' type terminations if needed.

RIM FINISH



Standard Trim



Glowing Ring

DIMENSIONS

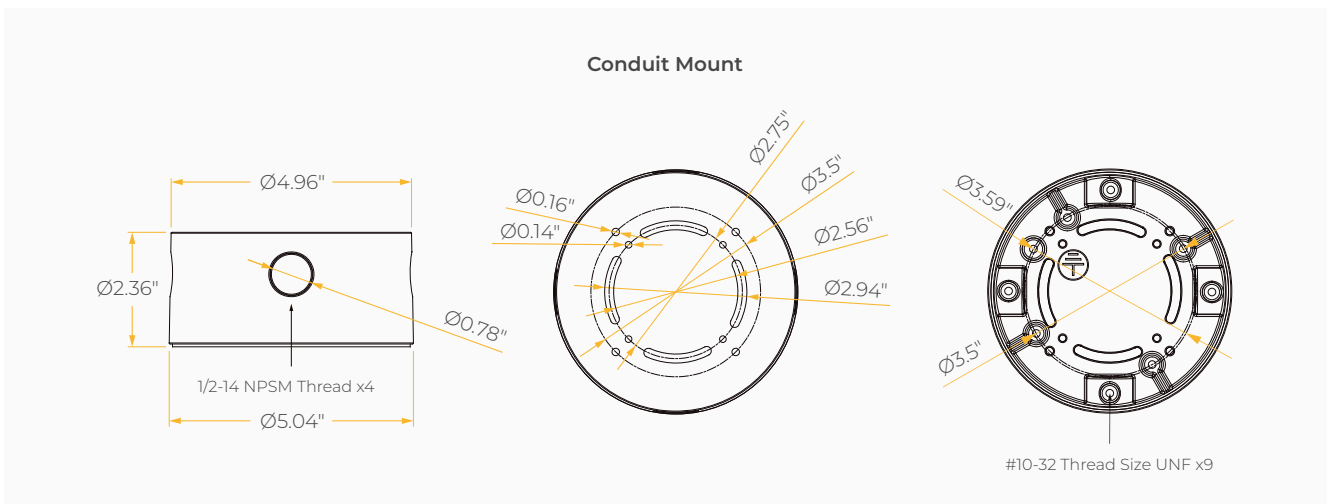
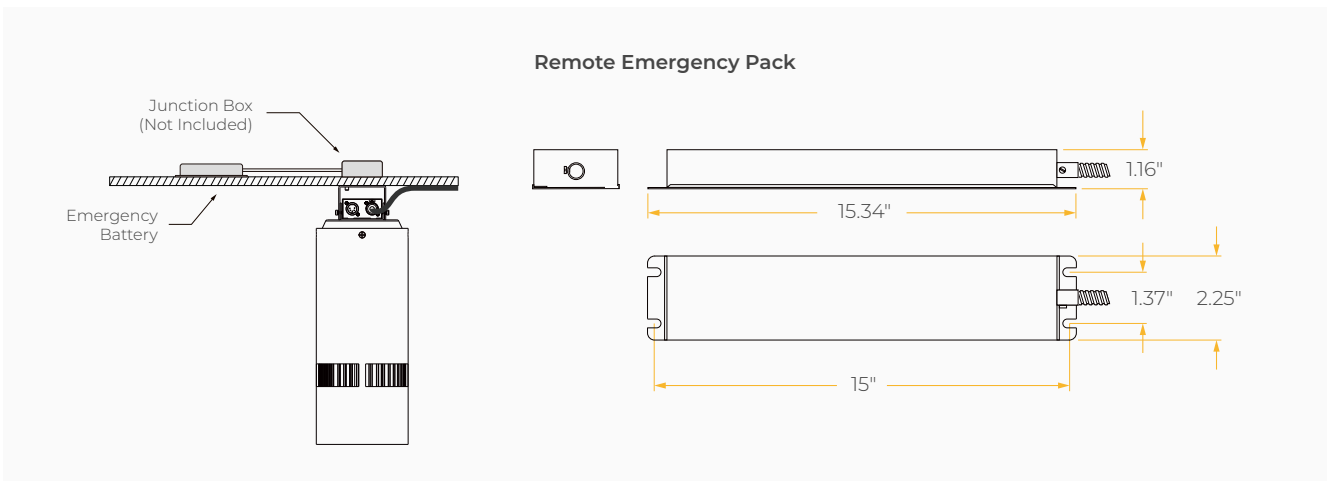
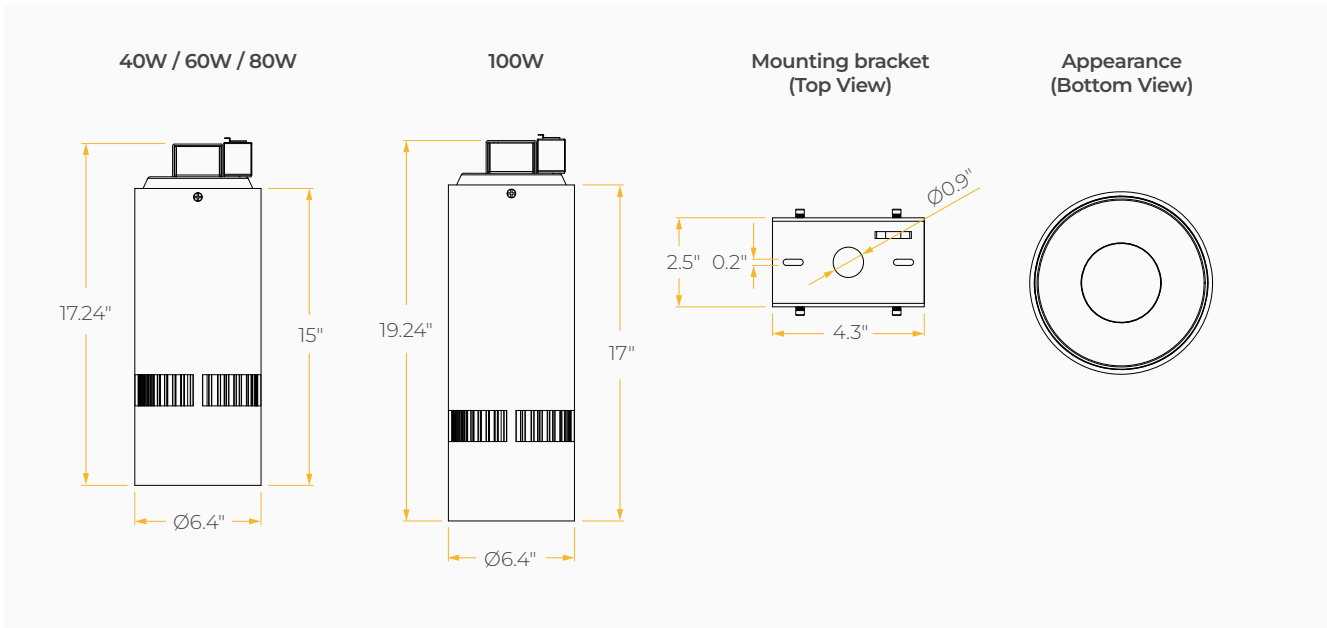

MOUNTING OPTIONS*

*Junction Box not included

